

B-004(1穴)

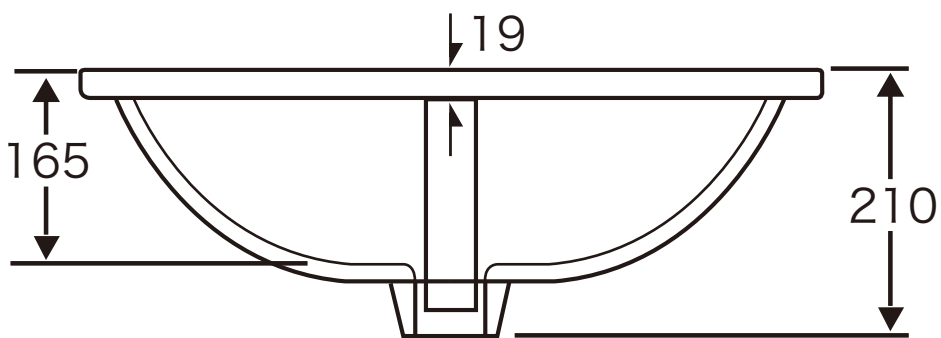

FRONT

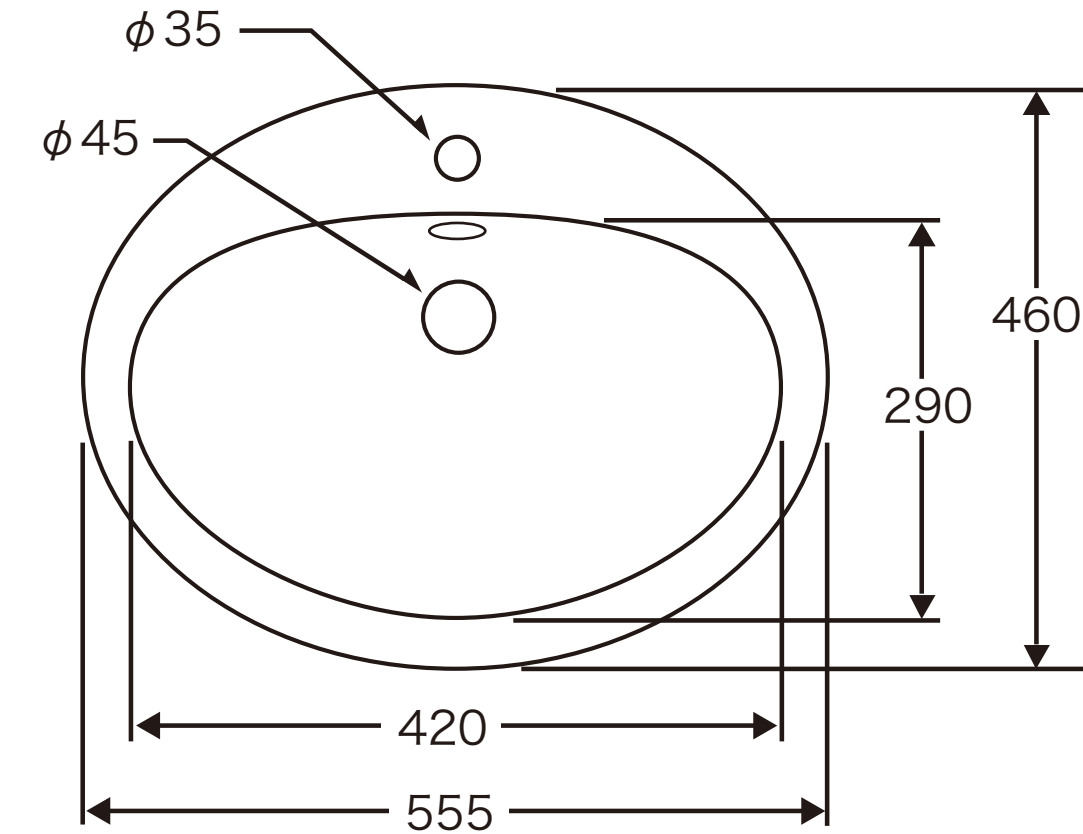
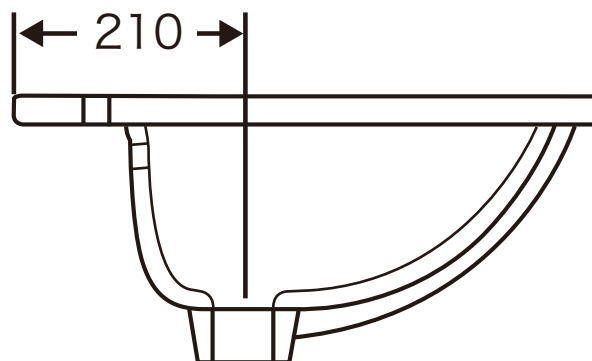

SIDE

B-004(3穴)

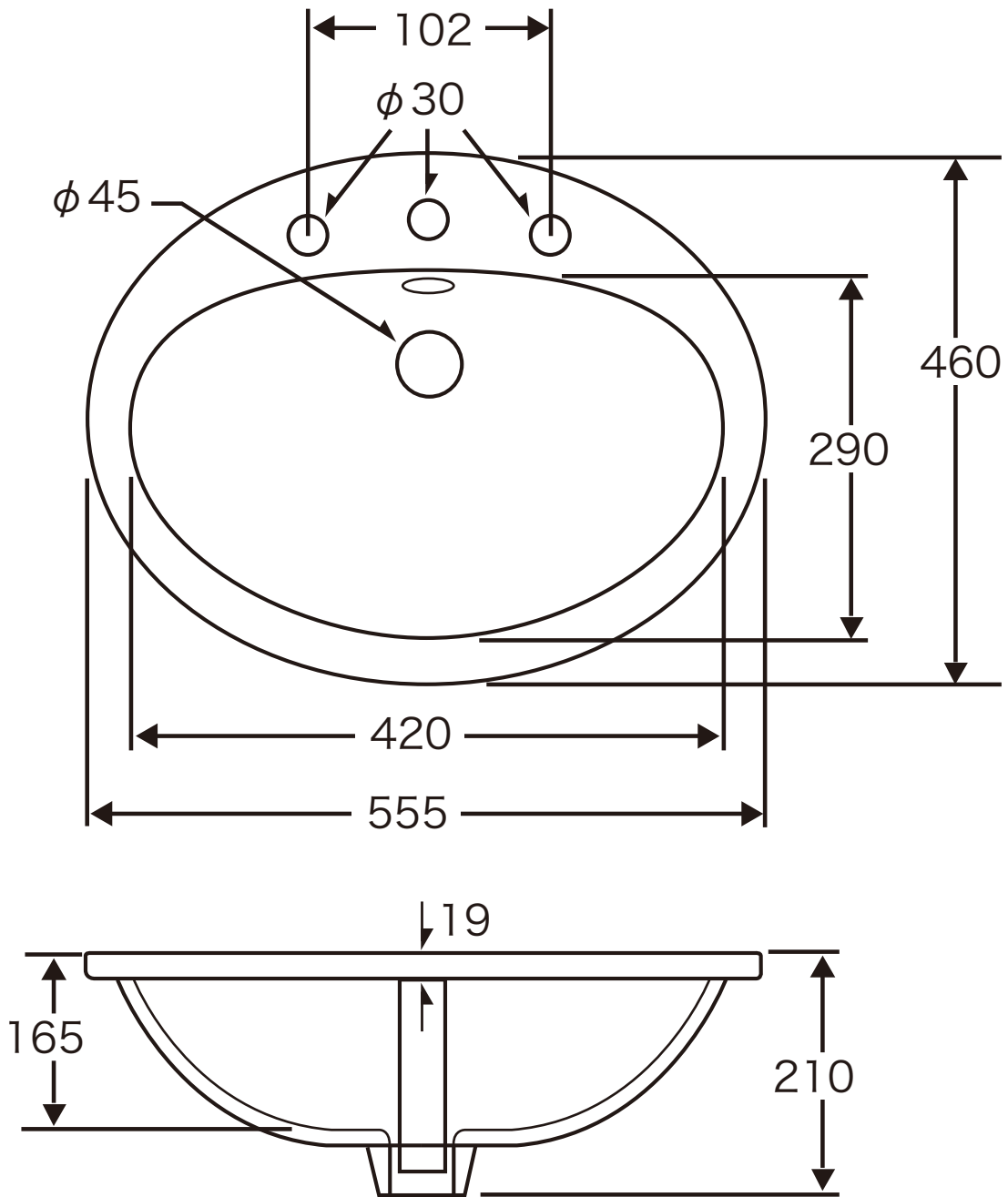

FRONT

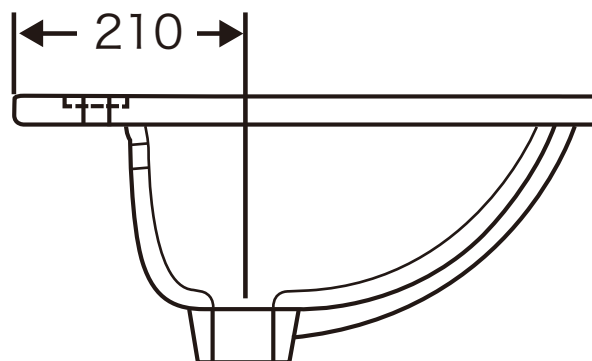

SIDE