

B-009(1穴)

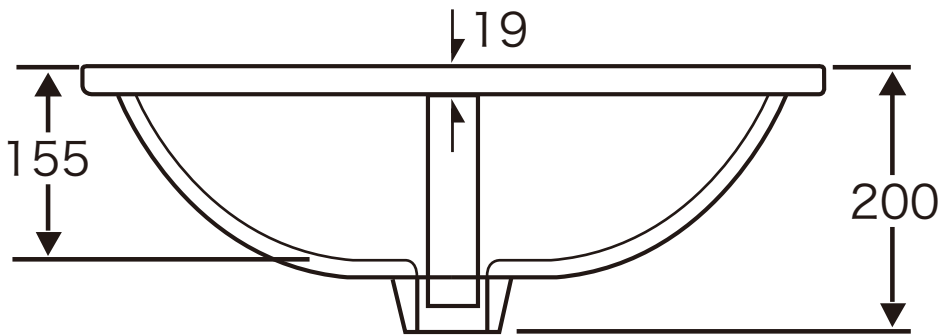

FRONT

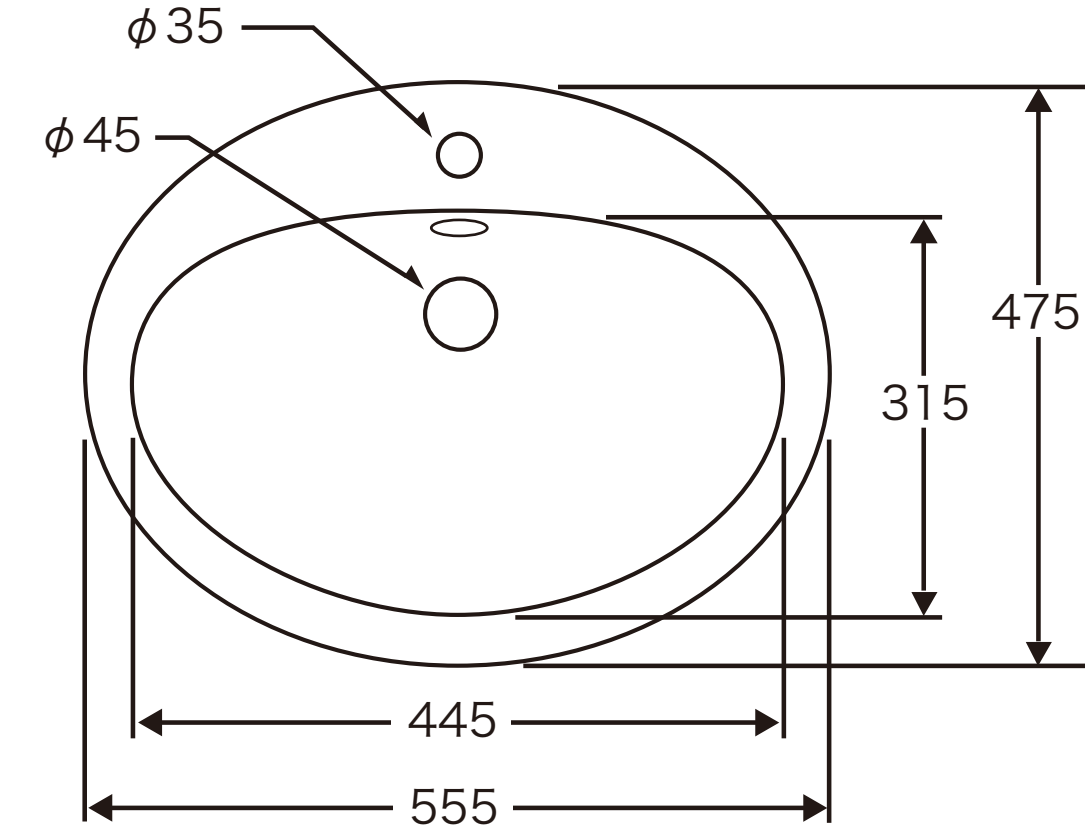
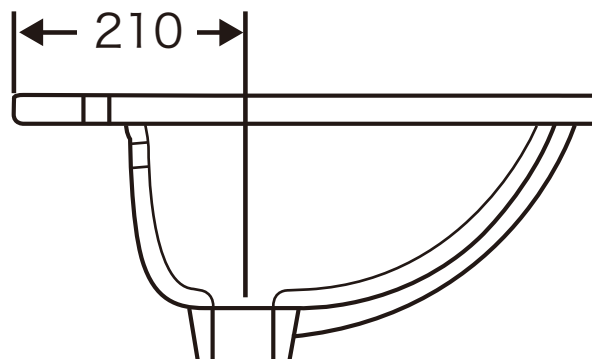

SIDE

B-009(3穴)

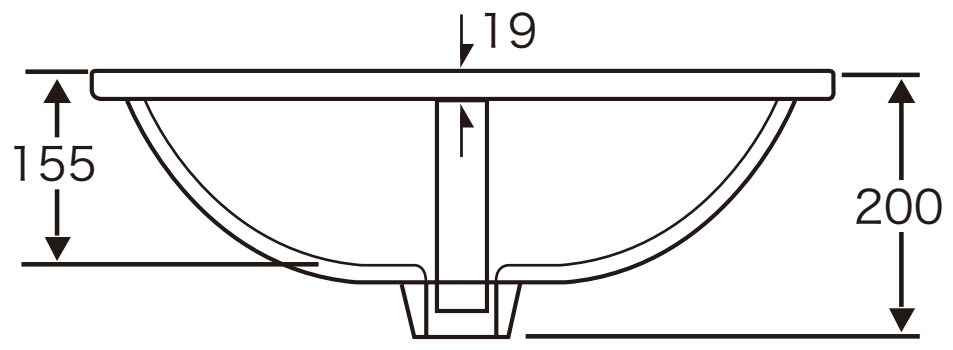
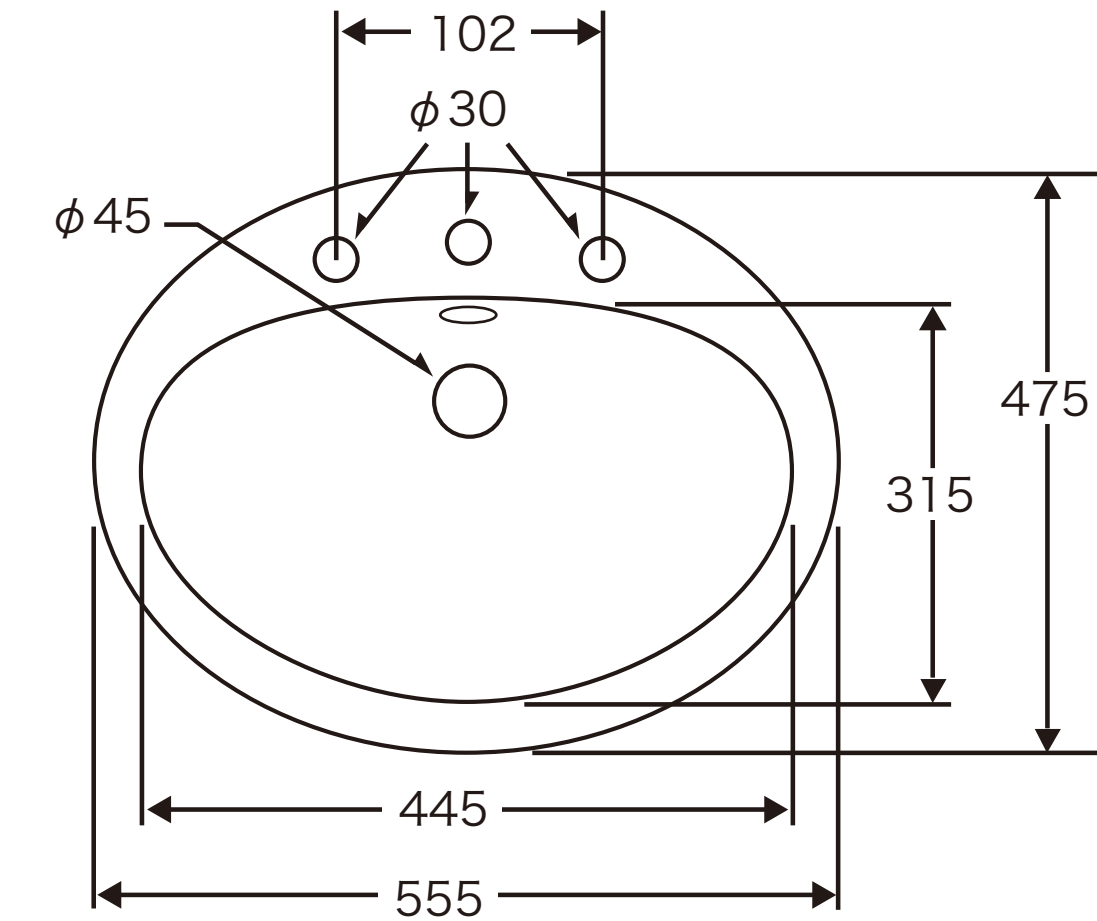

FRONT

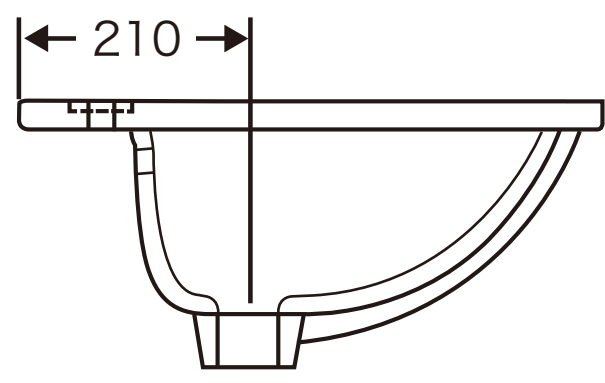

SIDE