

B-010(1穴)

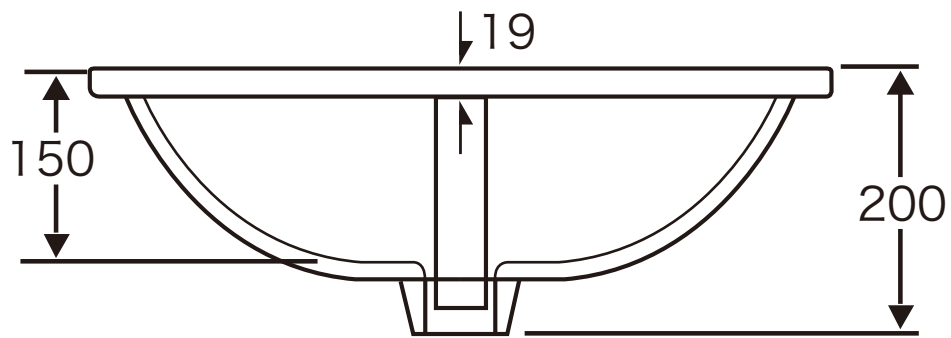

FRONT

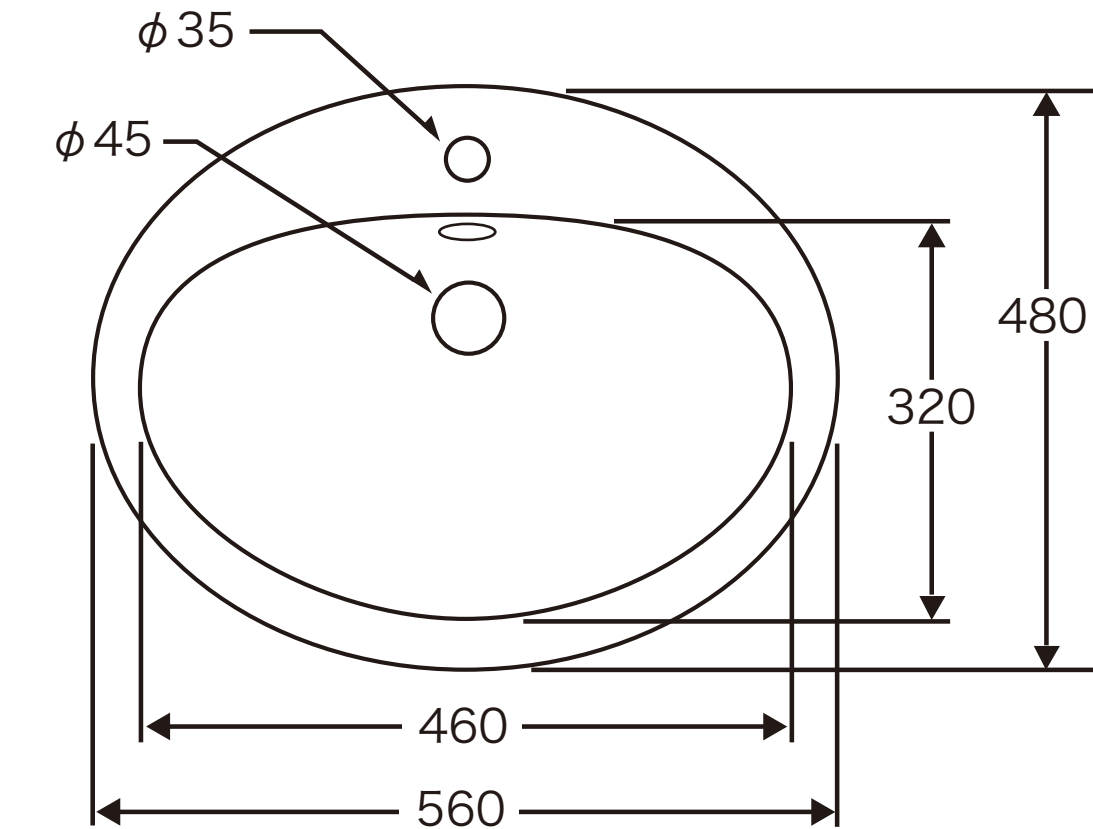
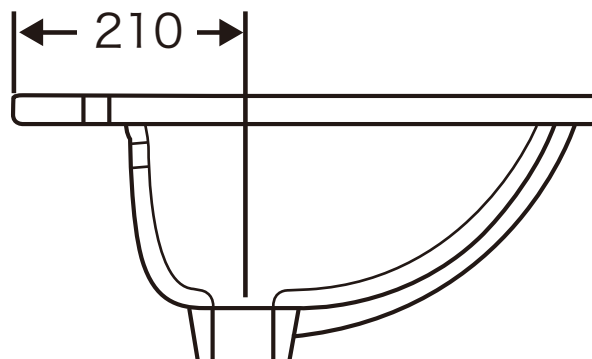

SIDE

B-010(3穴)

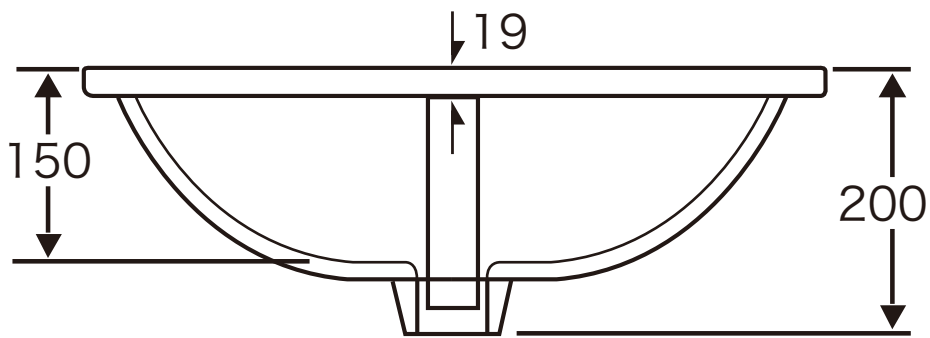
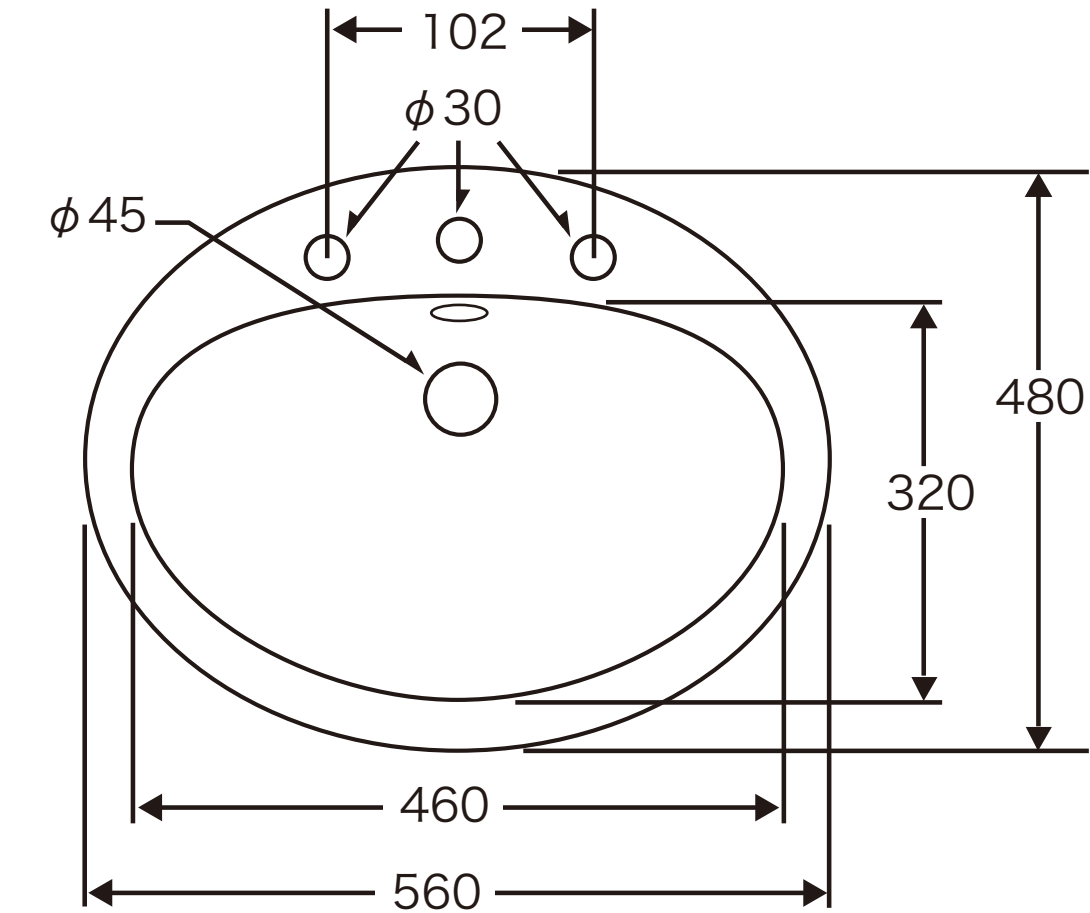

FRONT

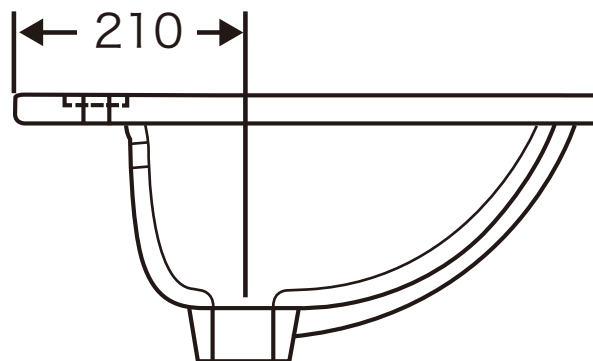

SIDE