

B-012(1穴)

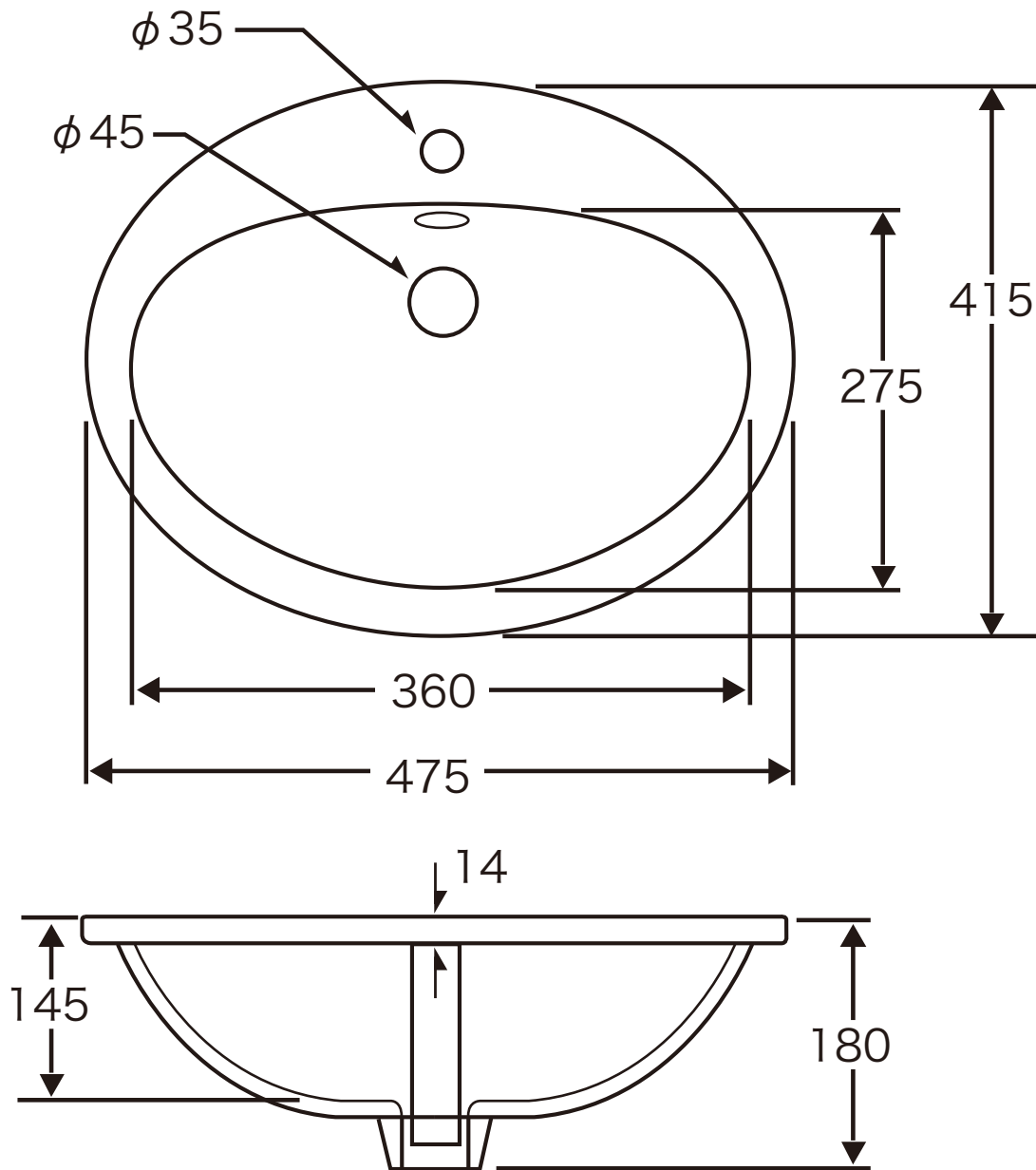

**FRONT**

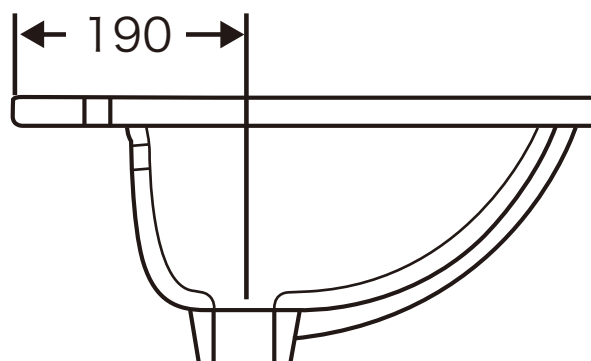

**SIDE**

B-012(3穴)

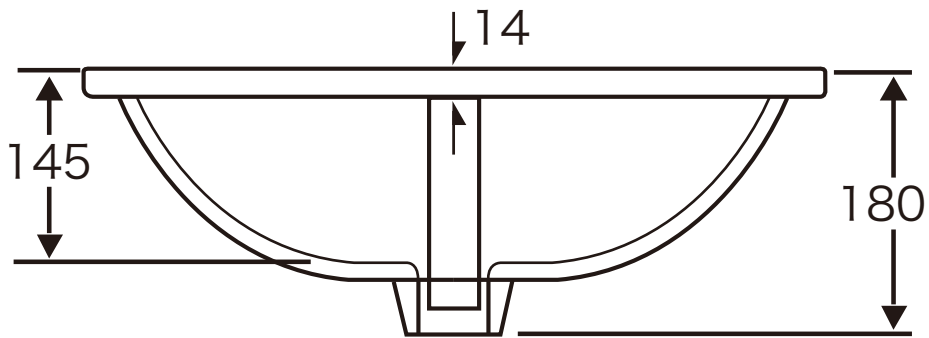
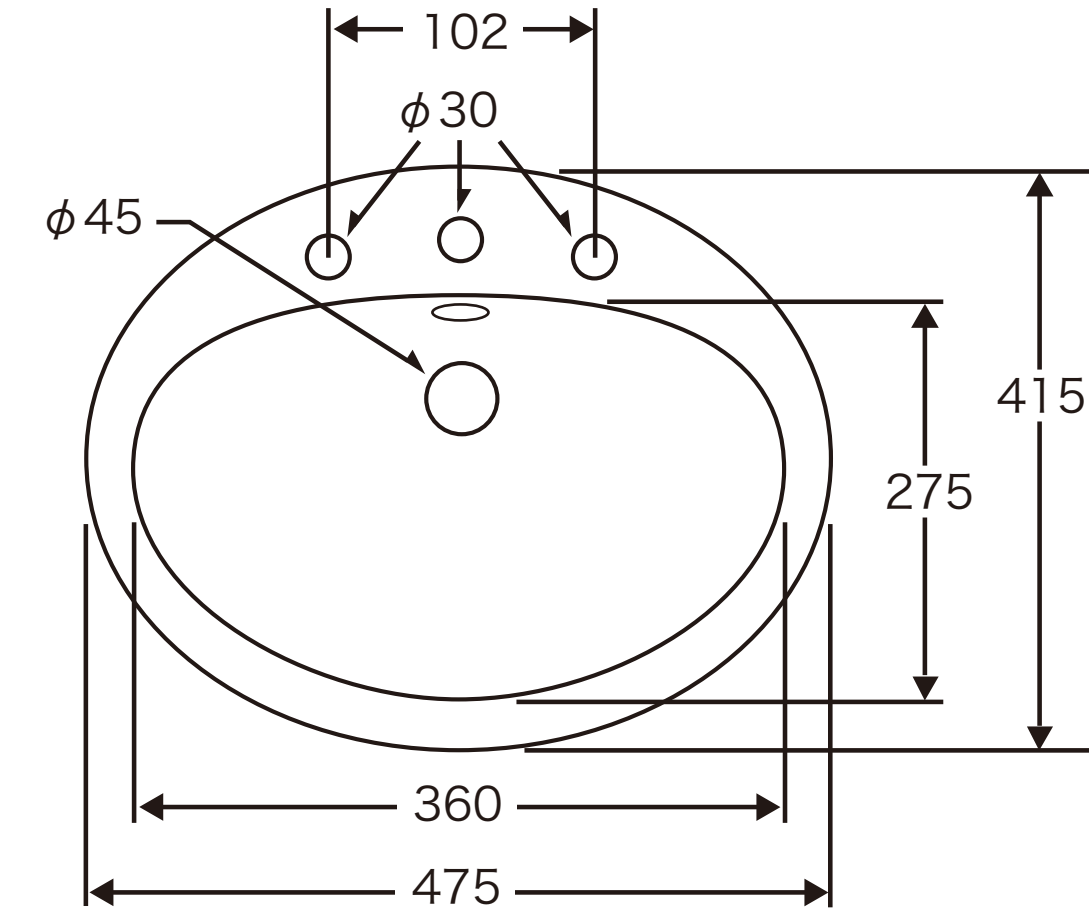

**FRONT**

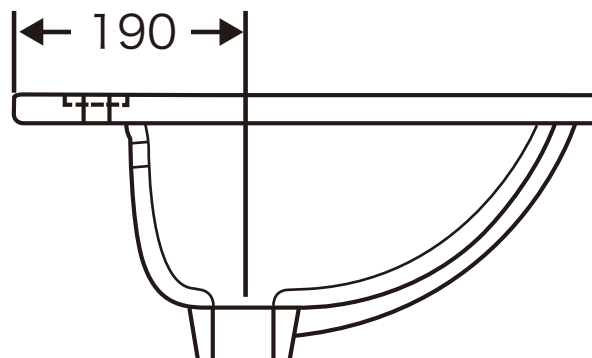

**SIDE**